



i.Print

User Guide



i.Print™ is a device that allows your crew members or manager to quickly and efficiently print product quality food rotation labels at the touch of a button.

No more:

Looking up hold times!

Calculating discard dates and times!!

Hand writing labels!!!

990894, I.Print™



Index

1. QUICKSTART! Operation
2. Printer
3. Operation Details
4. Specifications
5. Service Support, Warranty



Cool Tips! Look for this icon to learn about Cool I.Print™ Tips

1 - QUICKSTART! Operation

To get you printing fast!

- A. Make sure the I.Print™ is powered on and that labels are loaded in the Printer.
- B. Login
- C. Select a product
- D. Print!

Step A. Power up and Printer Labels

To power up your unit see section 4. Your I.Print™ was configured at the factory to print with the correct size labels shipped with the unit. We removed the labels for safe shipping. Go to Section 2 for instructions on loading the labels in the printer, its easy!



Step B. I.Print™ Login

When the unit is powered up or when logged out, the unit shows the ICC “splash screen”. To begin, touch the screen with the supplied stylus or your finger. **Never use a pen, pencil or any sharp object on the graphic display screen.**

The Manager Select screen will display. To log-in select a manager.



Cool Tip! Any screen where there is a yellow highlighted bar on a list, you can move the bar up or down and press the select key at the desired selection or simply touch the screen with the stylus or your finger.

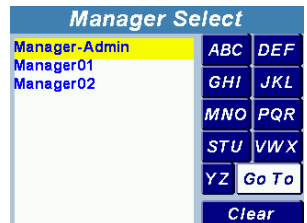

If the manager has Admin rights, you will be prompted for the login code. The default User list includes:

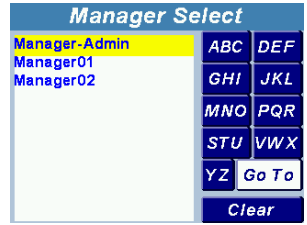

Manager-Admin

This manager has Admin rights and a default Login Code of 1234.

Enter the code then touch OK. If the number is invalid, the Warning screen will be displayed. Press Continue and enter the correct code. The Station Select Screen (if Stations are set-up) or Product Select screen (if no Stations are set-up) will display.

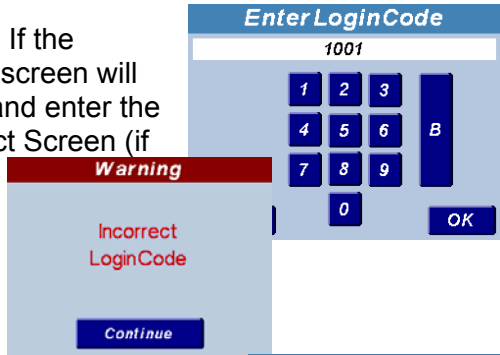

Temporary Password

For use if you cannot access the menu screen. ICC can supply you with a Temporary Password and help you resolve your problem. The Temporary Password will give you limited access to the menu and restrict you from certain settings.



Manager01 & Manager02

These managers do not have Admin rights or Login Codes and the Station Select Screen or Product Select screen will display immediately.

Step C. Select a Product

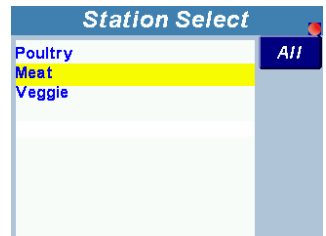

Station Selection

Product lists can be filtered and displayed based on food prep stations. This makes finding a product in a large list easier. Stations cannot be set-up using the Label Minder unit, but must be done using a computer and Excel, Notepad or other text editor and ported to the unit using the supplied USB Drive. See Section 3 under the heading **USB File Transfer.**



Touch a station (or use arrow down and Select), “Day Hold Salad Prep” for example. The screen will now show all the products in that station,

Touch a product (or use arrow down and Select), “Bacon” for example. The Print Label screen will display

If “All” was touched in the Station Select screen, all products in all stations will be displayed in alphabetical order.

The right dark blue column shows touch buttons labeled with 3 alphabetic characters ABC, DEF, etc.. Touching a button once will display the list beginning with the first letter of the product. Pressing it a second time displays the products beginning with the middle letter, a third press displays the products with the last letter.

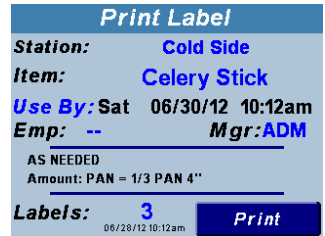

Step D. Print!

Once a product is selected, the Print Label screen will display. You can go back to the Station Select screen by touching the blue station “Day Hold Salad Pr...” in this example. You can also go back to the Product Select screen by touching the blue Product “Bacon”.



Cool Tip! Any text on the screen in blue can be touched to select an item, display a list or change a value.

Employee Select Screen

You cannot print a label until an Employee is selected. If you try to print a label with out selecting an Employee, you will get a Warning screen. Click Continue and select the name from the list.

You may also click on the blue “- -”next to “Emp:” to display the Employee Select screen.

Managers are Employees too and can be selected. Touch the desired employee

Number of Labels Selection

The default number of labels to print is shown. If you want to change the value, touch the blue number. Enter the number of labels to print and then press OK.

To print the label, touch Print on the screen or press the Print button on the unit.

CONGRATULATIONS! You have printed your first i.Print™ Label!

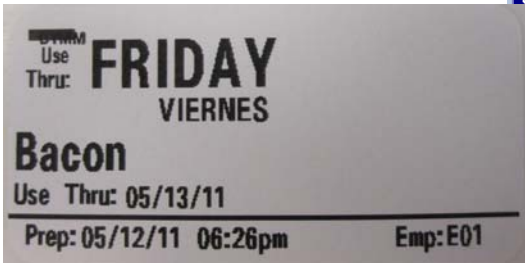
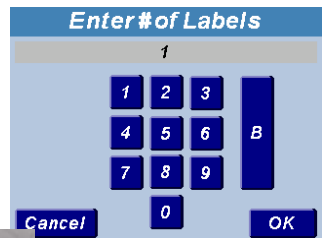
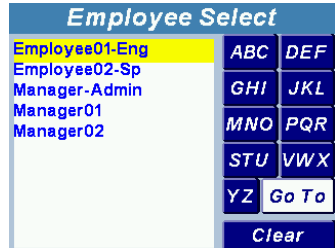

2 – Printer

Loading Paper

1: Remove the outside length of labels. During shipment, handling, or storage, the roll may become dirty or dusty. Removing the outside length of labels avoids dragging adhesive or dirty labels between the print head and platen.

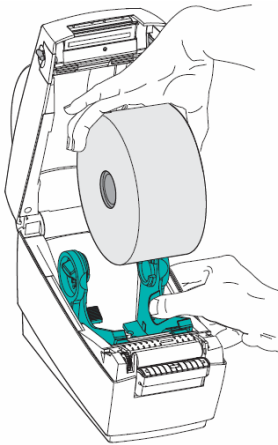
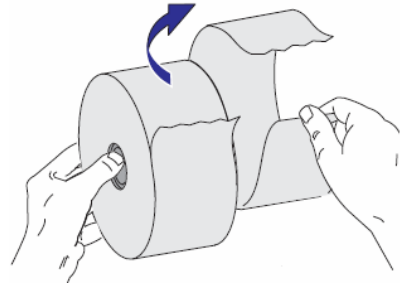

2: Open the label roll holders. Pull the labels guides open with your free hand and place the labels roll on the roll holders and release the guides. Orient the labels roll so that its printing surface will face up as it passes over the platen (drive) roller.

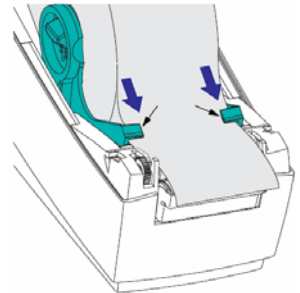

3: Pull the media so that it extends out of the front of the printer. Verify the roll turns freely. The roll must not sit in the bottom of the media compartment. Verify that media's printing surface is facing up. Push the media under both of the media guides.



4: Close the printer. Gently swing the top cover down onto the printer's base. Press down on both sides until the cover snaps closed, typically with an audible sound.

Cleaning the Printer

When using your i.Print™ over time the printer heads will become dirty and reduce the quality of the labels. It is important that you check the printer heads after every roll. If printer heads have residue or stains clean the printer.

1. Rub the cleaning pen across the dark area of the print head. Clean from the middle to the outside. This will move adhesive transferred from the edges of media to the print head outside of the media's path.
2. Wait one minute before closing the printer.

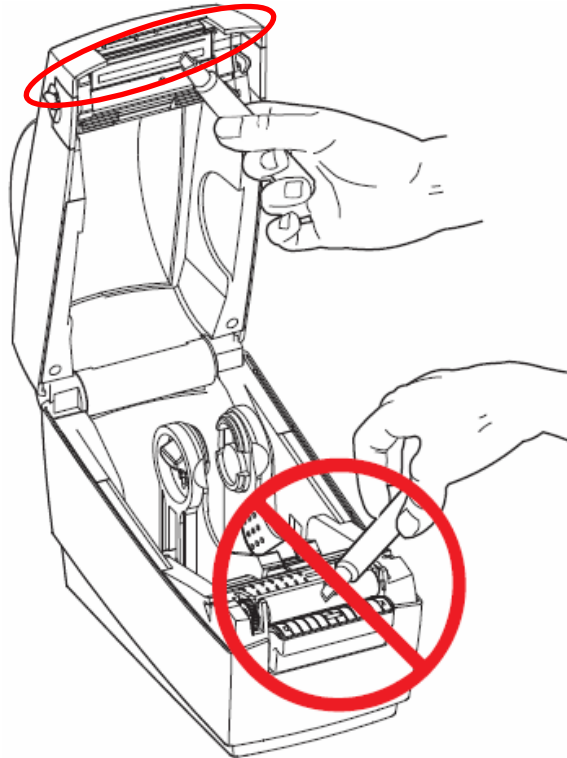

Removing the Roller from the Printer

If Labels happen to get stuck around the roller you may need to remove the roller to clean it of any labels and/ or adhesive.

1. Open the cover (and dispenser door). Remove media from platen area.
2. Pull the platen bearing latch release tabs on the right and left sides out and then rotate the arms straight up towards the front of the printer.

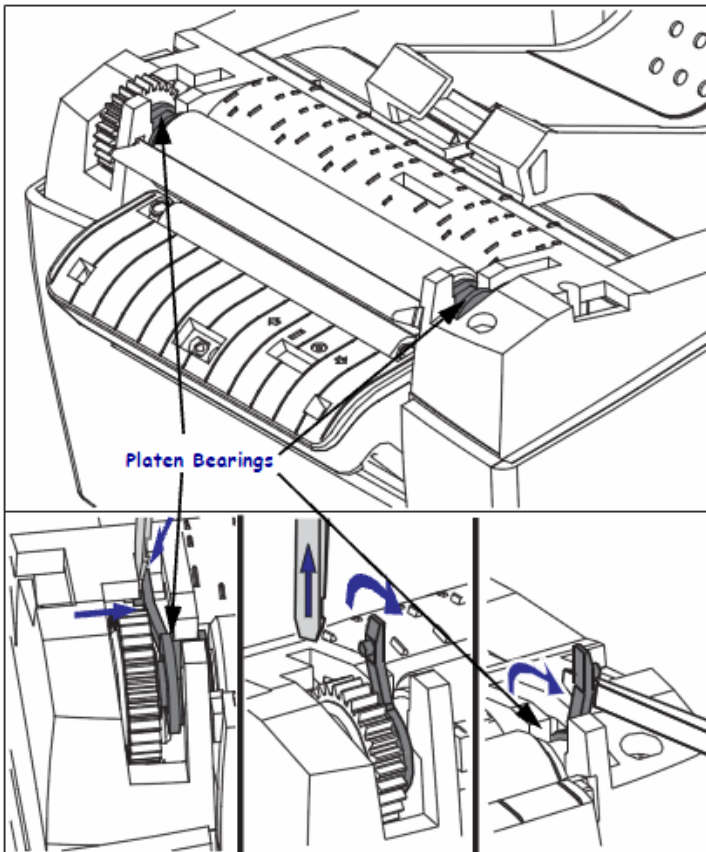

3. Lift the platen out of the printer's bottom frame.
4. Remove any Labels that may have attached to the roller. After Labels have been removed it is important to clean the roller with an alcohol swab.

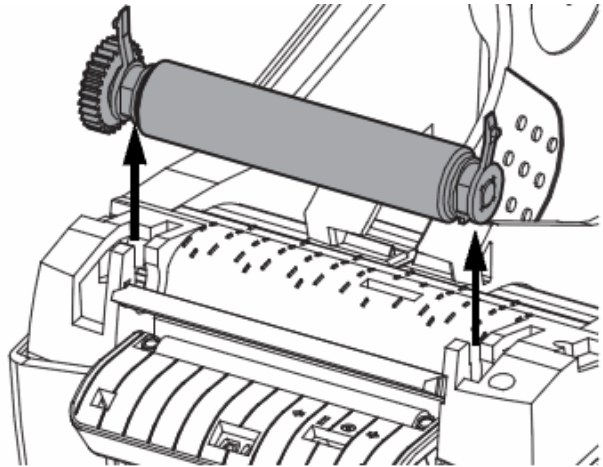

5. Install the roller in the printer.

6. Make sure the bearings and drive gear are on the shaft of the platen.

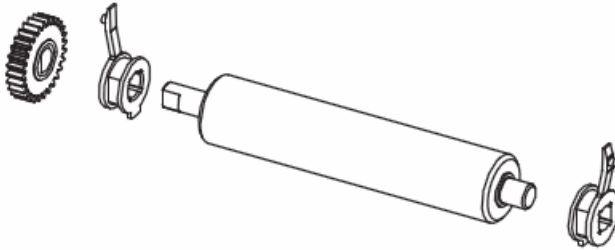

7. Align the platen with the gear to the left and lower it into the printer's bottom frame.
8. Rotate the platen bearing latch release tabs down on the right and left sides towards the rear of the printer and snap them into place. Allow the printer to dry for one minute.

3 – Operation Details

Not covered in the QUICKSTART! Operation

Employee User Types

There are 3 Employee User Types. An employee with a Manager User type is required to login to the system.

1. User Type – Manager, with Admin capabilities.

This requires a Login Code other than 0000. These Managers are prompted for this code when touching their name under the Manager Select Screen.

Admin capabilities allow access to the system menu which allows setup changes and to log-out from the menu screen. If the label formats include the Manager's initials, they will print on the labels.

2. User Type – Manager, without Admin capabilities

This requires a Login Code assigned of 0000. All Managers with a login code of 0000 login to the system by touching their name in the Manager Select screen but are not prompted for a code. These Employees do not have access to the Menu screen which allows system changes.

The purpose of this level is for a Manager to take responsibility for the prep label but not be able to make system changes.

If the label formats include the Managers initials, they will print on the labels. Regardless of the label formats, the Manager's and Employee's initials are recorded in the log file for each label printed.

In order to Log out of the system, go to the Print Label Screen and touch the Manager's initials in blue to the right of "Mgr:" and then touch "Clear" and login to another Manager.



3. User Type - Employee

An Employee can be setup with a password, but cannot log into the system or make system changes. Their initials will print on the label to the right of "Emp:"

The Employee taking responsibility for each label printed can be changed on the fly while on the Print label screen by touching the initials next to "Emp:".

A label cannot be printed unless an Employee is chosen. A Manager can be chosen as an Employee.

An Employee can clear their initials from the Print Label screen by touching their initials and touching "Clear" from the Employee Select screen.

The language displayed on the screens (English or Spanish) is dictated by the language assigned in the Employee's record.

Master sign-in

If all the Managers are deleted or the Manager's passwords are forgotten or lost, go to the Print label Screen, touch on the blue Mgr's initials, touch "Go To", "123", "12345", "OK". Then correct the Manager's information in the Edit Employees screen. This code should only be used for the purpose above and not to be used as a daily login.

Station Name Setup – The station names can not be setup on the I.Print™ interface. They are entered/ modified in the product list by using the procedure in the **Retrieving and Updating Data Files** section. The files are transferred to a USB drive then edited using Excel or a text editor.

Reprint Label – In Print Label Screen "Use By:" will be blue so that when touched it allows you to enter the Original Label Date.

Touching the "Use By" label will bring up a date entry screen whose title is "Enter Original Label Date". The entered Original Label Date cannot be later than today's real date. When

PrintLabel	
Item:	AmericanStar
UseBy:	Wed 03/10/10 11:56am
Emp:	BW Mgr: MS
AS NEEDED	
Amount: PAN – FULL PAN	
Labels:	1 Print
<small>03/03/10 11:56am</small>	

Reprint Label	
Station:	Thawing & Cooling
Item:	2% Milk
Use By:	Sun 01/22/12 06:56pm
Emp:	E01 Mgr: M01
Labels:	
LABEL01.CMD	1 Print
<small>01/20/12 06:56pm</small>	

Original Label Date is entered and you return to Print Label Screen and the title bar will be changed to "Reprint Label" and in Red. The Use By day of week, date and time displayed will be that of original label date. The entered Original Label Date will be treated as today's date on the reprinted label.

Select Employee-English & Spanish

Touch the blue initials or dashes next to the text "Emp:" when the **Print Label** screen is displayed, this will present the user with an **Employee Select** list. When selecting employees where the language is set to "Español" print related functions will be display

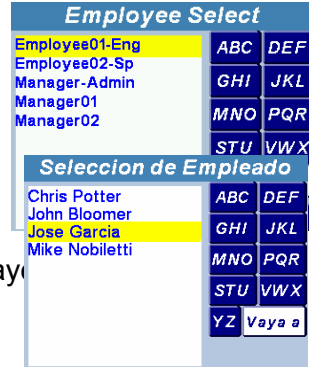

Print Label & Log File

Touch the Print button on screen or press the Print key on the unit. The printer will print the label(s). The information that was printed will be stored to a log file that can be transferred to a USB drive. See Section 3 under the heading **USB File Transfer.**

Printer Warning

If the printer reports an error such as: **Printer not connected, Out of Labels, or Cover Open, a Warning** screen will be displayed. Correct the problem, select Continue and attempt to print again.



Menu

Only a manager with Admin capabilities can use the Menu which is accessed by touching the top title bar of any screen heading. If an Employee user type or a Manager without Admin capabilities (user code of 0000) touches the top bar of any screen, there will be no response.



All the Menu options except **Change Manager** will be locked out after 1-minute of screen inactivity for all Managers with Admin capabilities. This does not apply to the “Master” user described in Section 3.



USB File Transfer

To transfer the files described below, insert the supplied USB drive into the rear of the unit, the red LED will light.



Send to USB Drive

Use this function to transfer the following types of files from the I.Print™ to the supplied USB drive:

- Product List: PRODUCT.CSV
- Employee list:USER.CSV
- Label Log file(s) LGyymmdd.CSV
- Label Format file(s): LABELFMT.CMD LABELxx.CMD

You can use up to 20 different Label Format Files: FMT & xx=01-19

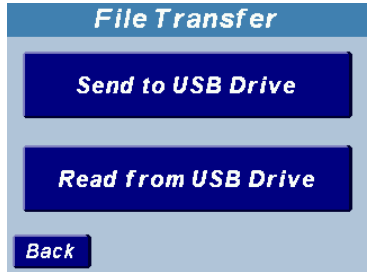

Read from USB Drive

Transfer the following types of files from the USB drive to the I.Print™:

- IAP Software Update: 892ONUSB.HEX
- Product List: PRODUCT.CSV
- Employee list:USER.CSV
- Label Format file(s): LABELxxx.CMD

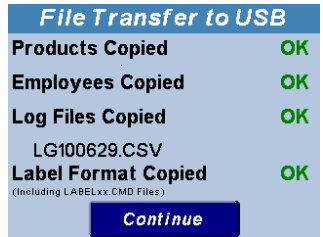

IAP (In Application Programming) files do not automatically flash the I.Print™ with the new HEX file. Refer to the **IAP** procedure under the **Systems Settings** heading later in this section to flash the unit with the new software.

Use a computer to place only the files that you wish to be transferred to the I.Print™ unit on the

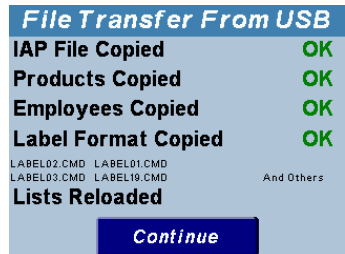

USB drive.

A label log file is created each day. As you transfer log files to the USB drive, they are deleted (except for the current date file which is transferred but not deleted).

When you are finished transferring files, simply remove the drive from the unit and store in a safe place for later use. When removing the drive from a computer be sure to comply with any procedures needed based on the Windows O/S to safely remove USB drives and prevent corrupting the format.

If there is a problem with the USB drive the **Warning** screen will be displayed. Remove the USB drive and reformat it on the computer.



Edit Products

To Edit or Delete a product use the alpha keys or "Go To" key to highlight the desired product. Press the Select key or touch the product name to display the edit product screen

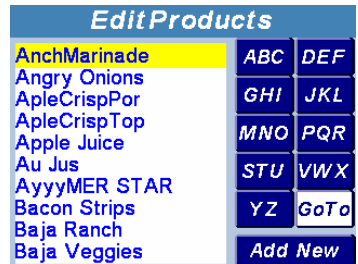

Edit Product

Touch the Item's blue name on the touch screen to edit the name. The alpha keyboard will display. Using the touch screen keypad enter the new product name. If Stations were originally set-up, the Station assigned to the product will display under the Item and you can change it by touching it and selecting another Station or "none". When using Multiple Label Formats you can also assign the proper FMT number to the Item shown. Press the Save key to save the product name or Cancel to leave the existing product name unchanged.

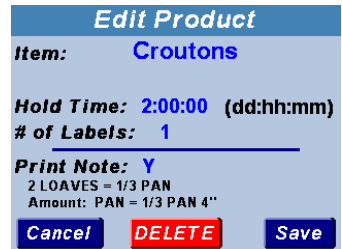

Hold Time:

Touch the blue Hold Time to bring up the Numeric keypad. Enter the Hold Time separated by “:” in days:hours:minutes. Touch the OK button to save the new hold time or Cancel to leave the existing Hold Time unchanged.

of Labels:

Touch the blue number next to “# of Labels:” to bring up the Numeric keypad. Enter the number of labels to print. Touch the OK button to save the number.

Print Note:

Notes are loaded into the i.Print™ through the USB File Transfer feature and cannot be edited from the screens. The notes will print if Print Note is Y and the field for the notes is set up for the label. Touch the blue letter to toggle Y and N.

Delete Products

With the **Edit Product** screen displayed, press the Delete button to delete the product. An **Are You Sure?** prompt screen will be displayed to confirm the delete. Touch No or Yes.

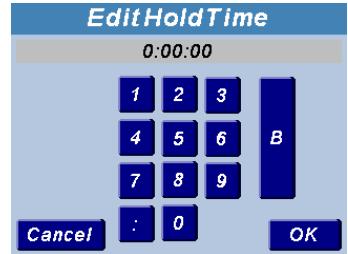
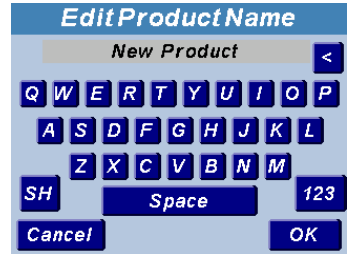

Add New Product

Touch the **Add New** button from the Edit Products to edit screen. The **Add New Product** screen will be displayed

Touch the blue “New Product” on the touch screen to bring up the alpha keyboard. Enter the information and touch the OK button.

If Stations have been previously set-up, you have the option to assign the new product to a station by touching the 2 blue dashes next to “Station” and selecting an existing Station or “None”

Enter the Hold Time and # of Labels. Label notes can not be set up from the screen, only by using the **USB File Transfer** feature.

When the information is correct, press the Save button to save the new product or Cancel button to cancel.

Edit Employees

The employee list contains the following:

- Name** – Name of the Employee
- Initials** – Employees initials that will print on the label if set-up in the label format
- User Type** - used to distinguish between a Manager and Employee. Employees cannot log into the system
- Login Code** - User Log-in code
- Language** – Determines if words are displayed in English or Spanish.

Touch the employee name to edit

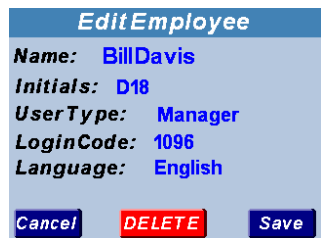
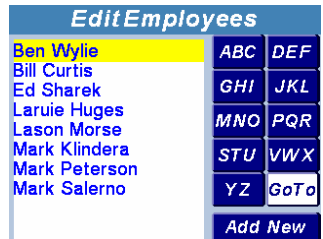
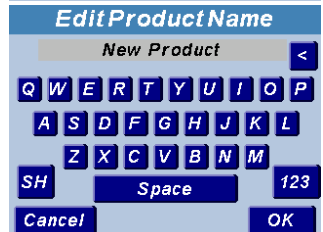

Edit Names

Touch the employees blue name. The Edit Employee name will be displayed with the alpha keypad. When finished press the OK or Cancel button. The display will change to the **Edit Employee** screen.

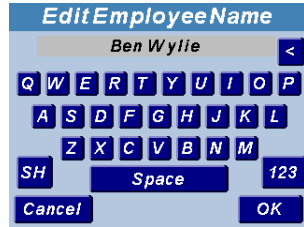

Edit Initials, User Type and Login Code & Language

On the Edit Employee screen, touch the area in blue to edit, change the information and save.

Delete Employee

When the **Edit Employee** screen is displayed press the Delete button to delete the user. The **Warning** screen will be displayed to confirm the deleted names. Press the continue button to delete or press cancel, to keep the user.



Add New

To add a new user, press the Add New button from the Edit Employee screen. The Add New Employee screen will be displayed. Fill out the information by pressing the blue words and entering the information. A Login Code of 0000 is used for Managers without Admin or disables the employee login capabilities. Any other code will enable Admin capabilities.

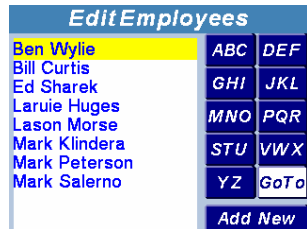

Press the Save button to save the new user or Cancel button to cancel. The display will change to the **Select User to Edit** screen.



System Settings

Touch the **System Settings** button to display this screen.

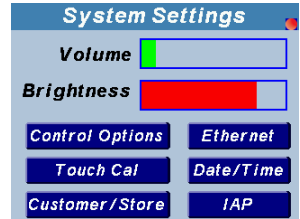

Volume and Brightness

Use the stylus or your finger to change the volume of the unit’s sounder or screen brightness. Slide the bars to the left to decrease the settings or to the right to increase the settings. The changes are immediate and automatically saved.

Control Options

Auto Clear Time: The screen will automatically revert back to Station Select (if Stations are set-up) or Product Select screen after the set number of minutes of inactivity. Set the field to 0 to disable this feature.

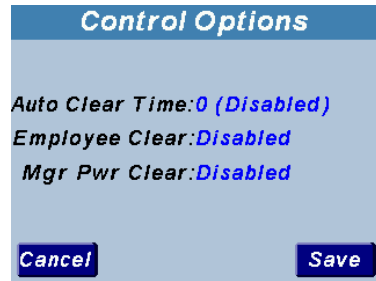

Manager Pwr. Clear: When Enabled the Managers name will be cleared in the Print Preview screen when the unit is powered up. If Disabled when turning the power off – on the managers name will be recalled in the Print Preview screen.

Employee Clear: Enabled, the Emp: selected on the Print Label screen will be cleared after the number of minutes set in the Auto Clear Time field after idle screen activity. If the Employee Clear field is set to Disabled, the Auto Clear parameter is ignored and even after recycling power the employee name will reappear in the Emp: field. If the Auto Clear Time is set to 0, the Emp: will not clear.



Touch Cal

Pressing the button displays the **Touch Calibration** screen. It should be performed if the buttons become offset from the screen. Follow the instructions on the

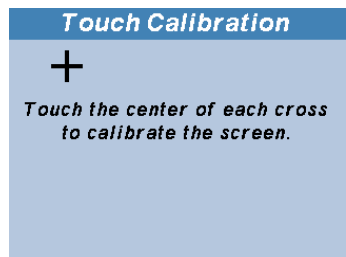

screen and press Continue when you receive the Congratulations message.

Customer/Store and Ethernet

These set-up screens are used to be able to transfer files via internet. Refer to the separate guide “I.Print™ Internet Guide” for instructions on this feature.

Date/Time: This screen can only be entered if FTP Polling is disabled in the Ethernet screen. If FTP Polling is enabled the Tab will be grayed out. Pressing the button displays the **Set Date/Time** adjustment screen. Touch the blue numbers to enter the date and time. Touch the blue date format to toggle: mm/dd/yyyy, dd/mm/yyyydd-mm-yyyy Touch the blue time format to toggle: hh:mm am/pm, hh:mm 24 Hr Military. Press the Setup Tab to enter the “Set Up Time” screen. Time zone relates to the GMT or Greenwich Mean Time. For example Eastern time will be set to -5, Central will be set to -6, Mountain time -7, and so on. “Observe DST” will be set to yes in all areas that follow Daylight Savings Time. Touch Save to save changes, Cancel to cancel changes. “Download Time” refers to the time that is set automatically by the servers. Set this to yes if you will be getting the time from the SFTP servers. Set Download Time to no if you will be entering the time manually.

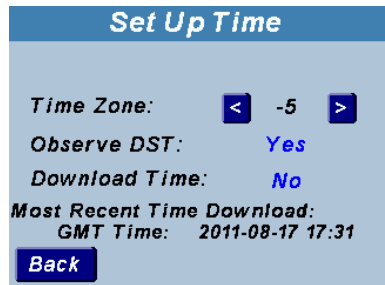

IAP (In Application Programming)

Use this function to upgrade the I.Print™ software with a new version. An IAP HEX file must be named 892ONUSB.HEX and is transferred via USB to the unit. Refer to procedure under the **USB File Transfer** heading earlier in this section to transfer the



new software file. Once the file is transferred to the unit, touch Get and then Program.

The procedure will take approximately 2-3 minutes at which time a message will appear “Programming Complete Recycle Power”. Unplug the power cord and then plug back in and look for the new version number on the splash screen.



Log Out Manager

Touch **Log Out Manager** to display the splash screen and log in a new manager.

File Editing

To edit files on a computer using Excel or a text editor, transfer the files to the USB drive (refer to procedure under the **USB File Transfer** heading earlier in this section) then transfer to your computer. **If you are unfamiliar with editing files you might corrupt the files causing the I.Print™ unit to malfunction.** Please contact ICC for assistance (charges may apply).

Files you can edit:

PRODUCT.CSV - Product List file

USER.CSV – Employee File

Edit rules:

1. **IMPORTANT! Do not use commas in any field as this will result in a malfunction of the I.Print™**
2. You can expand the column widths to view the entire Item field (Product Name) and Note Lines
3. Always re-save the file with the CSV format.
4. Do not enter text in any other cell except to the right of a record type and under an existing header.

5. You can use any of the following characters:

A	B	C	D	E	F	G	H	I	J	K	L	M
N	O	P	Q	R	S	T	U	V	W	X	Y	Z
a	b	c	d	e	f	g	h	i	j	k	l	m
n	o	p	q	r	s	t	u	v	w	x	y	z
1	2	3	4	5	6	7	8	9	0	-	:	;
()	\$	&	@	“	%	#	?	!	^	.	

Label Format Files: LABELFMT.CMD and LABEL01.CMD-LABEL19.CMD. These files are set-up by ICC and are not user editable. Please contact ICC i.Print™ support at 1-631-673-5100 to order a Label Format change.

PRODUCT.CSV – Product List File

Record Types:

V – Version#: Product List version#

Do not edit the version#

S – Station: Products below this record assigned to that station

	A	B	C	D	E	F	G	H	I	J	K
1	V	124									
2	S	Day Hold Salad Prep									
3	H	Item	HoldTime	#Labels	Fmt #	Ptr#	PrintNotes	NoteLine1	NoteLine2	LabelLine1	LabelLine2
4	P	Bacon	1:00:00	1			1 N				
5	P	Buttery Sp	4:00:00	1			1 N				
6	P	Coffee (opt	0	1			1 N				
7	P	Crispy Oni	1:00:00	1			1 N				
8	P	Eggs-Liqui	1:00:00	1			1 N				
9	P	Ham (oper	1:00:00	1			1 N				
10	P	Stacker S:	4:00:00	1			1 N				
11	S	Thawing & Cooling									
12	H	Item	HoldTime	#Labels	Fmt #	Ptr#	PrintNotes	NoteLine1	NoteLine2	LabelLine1	LabelLine2
13	P	Ciabatta B	2:00:00	1	1		1 N				
14	P	Croissants	2:00:00	1	1		1 N				
15	P	Iced Coffe	2:00:00	1	1		1 N				
16	P	Pies	2:00:00	1	1		1 N				
17	S	Board Prep									
18	H	Item	HoldTime	#Labels	Fmt #	Ptr#	PrintNotes	NoteLine1	NoteLine2	LabelLine1	LabelLine2
19	P	Cheese	4:00	1	3		1 N				
20	P	Ham	2:00	1	3		1 N				
21	P	Lettuce	4:00	1	3		1 N				
22	P	Onions	8:00	1	3		1 N				
23	P	Tomatoes	4:00	1	3		1 N				
24	S	General Use Label									
25	H	Item	HoldTime	#Labels	Fmt #	Ptr#	PrintNotes	NoteLine1	NoteLine2	LabelLine1	LabelLine2
26	P	3-Cheese	5:00:00	1	4		1 N				
27	P	A.1. Steak	29:00:00	1	4		1 N				
28	P	English Mt	6:00:00	1	2		1 N				
29	P	Shake Syr	20:00:00	1	4		1 N				
30	P	Smoky Ch	9:00:00	1	4		1 N				
31	P	Smoky Tor	9:00:00	1	4		1 N				
32	P	Tortilla Hol	4:00:00	1	2		1 N				
33	P	Tortilla Red	59:00:00	1	2		1 Y				
34	P	Whipped T	4:00:00	1	2		1 Y				

Enter the Station Name

H – Header: for reference

Do not edit the Header names

P – Product: Product information for label printing

Item: Product name

Hold Time: Enter in the format dd:hh:mm

#Labels: Enter the default # of labels to print

Fmt# : Enter the Label Format# (blank-19) which will cross reference to the following files (20max),

blank = LABELFMT.CMD,

1= LABEL01.CMD

2 = LABEL02.CMD, etc. up to 19= LABEL19.CMD

Prt#: For optional multiple printers, Default is blank for one printer. Contact ICC for more information.

PrintNotes: Y or N – Toggles NoteLine 1 & 2 to print or not.

NoteLine1: Product note1, shown on Print label screen, will print if label format calls the field.

NoteLine2: Product note2, shown on Print label screen, will print if label format calls the field.

LabelLine1: Expanded Product name1 - not shown on any screen. Will print if label format calls the field.

LabelLine2: Expanded Product name2 - not shown on any screen. Will print if label format calls the field.

USER.csv – Employee file

	A	B	C	D	E	F
1	V	320				
2	H	Name	Initials	Type	Code	Language
3	U	EmployeeE	E01	0	0	0
4	U	EmployeeE	E02	0	0	1
5	U	Manager-A	ADM	2	1234	0
6	U	Manager01	M01	1	0	0
7	U	Manager02	M02	1	0	0

Record Types:

V – Version#: Product List version#

Do not edit the version#

H – Header: for reference

Do not edit the Header names

U – Employee: Employee information

Name: Enter the Employee name

Initials: Enter the 3 character initials (numbers are allowed)

Type: Enter the Employee type, 0=Employee, 1=Manager
2=Admin

Code: Enter the Login code for Managers or Employees. A Manager’s login code of 0 blocks that manager from Admin functions. An Employee’s login code of 0 disables employee login.

Language: 0=English, 1=Spanish

4 - I.Print™ Specifications

990894, I.Print™

Physical

11.2" L x 8.5" D x 7.75: H, Weight appx: 5 lbs.

Power Supply

Input - 100 VAC to 240 VAC

Output - 24 VDC, 2.5 amps

Control Specifications

Memory/Mass Storage

64MB USB Drive supplied

2GB Internal SD card installed

Display

3.5 inch Color TFT 320 X 240 Resolution (QVGA) 256 colors

Touch Screen Contrast/Brightness software adjustable

Interface/Communications

RS232 Serial Interface to printer

10/100Base-T Ethernet Port TCP/UDP/IP supported

USB interface

Ambient Operating Environment

Temperature 41F to 104F (5C to 40C), Humidity 30-85%

Audio

Speaker 20mm x 40mm 89db Volume adjustable

Options

Scanner

Customizations Available

Custom graphics to labels

Network Connectable for central updates

Real Time Clock sync with Network

Zebra Printer Specifications

Print

Type - Direct Thermal
Resolution - 203dpi
Max Print Width – 2.12”
Max Print Length – 68”
Print Speed – 2-4 IPS
Reflective and Transmissive Paper Sensor

Media Size

Max Roll Diameter – 5”
Width - .6” – 2.36”

Interface/Communications

Serial and USB interfaces

Ambient Operating Environment

Temperature 41F to 104F (5C to 40C)
Humidity 30-85%

Barcode Symbolologies

Code 39, Code 93, Code 128 (subset A,B,C), UCC 128, UCC/EAN-128
K-Mart, UCC/EAN-128, UPC A/E (add on 2 & 5), I 2 of 5, I 2 of 5 with
shipping bearer bars, EAN 8/13 (add on 2 & 5), Codabar, Post NET,
EAN 128, DUN 14, MaxiCode, HIBC, Plessey, random weight, Telepen,
FIM, China Postal Code, RPS 128, PDF417, Datamatrix code, (QR
code)

Fonts

Resident scalable font, supports font download, Unicode fonts and
resident bitmap fonts.

Self Check Functions

Paper End, Cover Open, Test Print, Head Check

5 - Service Support, Warranty

Support

For Customer Care call: Integrated Control
+1-631-673-5100

Support available: 8am to 5pm ET

Warranty

1 Year depot service for material and workmanship
Return to customer shipping included.

All returns require a return authorization number that may be requested through the support telephone number.

Replacements will require a credit card guarantee prior to shipping.

